

Approval body for construction products  
and types of construction

Bautechnisches Prüfamt

An institution established by the Federal and  
Laender Governments



## European Technical Assessment

ETA-18/0979  
of 5 July 2023

English translation prepared by DIBt - Original version in German language

### General Part

Technical Assessment Body issuing the  
European Technical Assessment:

Deutsches Institut für Bautechnik

Trade name of the construction product

Injection System W-VIZ dynamic

Product family  
to which the construction product belongs

Post-installed fasteners in concrete, under fatigue cyclic  
loading

Manufacturer

Adolf Würth GmbH & Co. KG  
Reinhold-Würth-Straße 12-17  
74653 Künzelsau  
DEUTSCHLAND

Manufacturing plant

Werk 1  
Werk 3

This European Technical Assessment  
contains

23 pages including 3 annexes which form an integral part  
of this assessment

This European Technical Assessment is  
issued in accordance with Regulation (EU)  
No 305/2011, on the basis of

EAD 330250-00-0601, Edition 06/2021

This version replaces

ETA-18/0979 issued on 12 November 2018

The European Technical Assessment is issued by the Technical Assessment Body in its official language. Translations of this European Technical Assessment in other languages shall fully correspond to the original issued document and shall be identified as such.

Communication of this European Technical Assessment, including transmission by electronic means, shall be in full. However, partial reproduction may only be made with the written consent of the issuing Technical Assessment Body. Any partial reproduction shall be identified as such.

This European Technical Assessment may be withdrawn by the issuing Technical Assessment Body, in particular pursuant to information by the Commission in accordance with Article 25(3) of Regulation (EU) No 305/2011.

## Specific Part

### 1 Technical description of the product

The Injection System W-VIZ dynamic is a torque controlled bonded anchor consisting of a cartridge with injection mortar WIT-VM 100, WIT-VIZ, WIT-EXPRESS or WIT-VIZ express, an anchor rod with expansion cones and external connection thread, a centring ring (only for through-setting installation), a conical washer, a hexagon nut with spherical contact surface and a locknut. For the pre-setting installation a conical washer with a bore is used. Alternatively, the hexagon nut with spherical contact surface can be replaced by a spherical disc with hexagon nut.

The load transfer is realised by mechanical interlock of several cones in the bonding mortar and then via a combination of bonding and friction forces in the anchorage ground (concrete).

The product description is given in Annex A.

### 2 Specification of the intended use in accordance with the applicable European Assessment Document

The performances given in Section 3 are only valid if the anchor is used in compliance with the specifications and conditions given in Annex B.

The verifications and assessment methods on which this European Technical Assessment is based lead to the assumption of a working life of the anchor of at least 50 years. The indications given on the working life cannot be interpreted as a guarantee given by the producer, but are to be regarded only as a means for choosing the right products in relation to the expected economically reasonable working life of the works.

### 3 Performance of the product and references to the methods used for its assessment

#### 3.1 Mechanical resistance and stability (BWR 1)

Essential characteristic (static and quasi-static loading and seismic loading)	Performance
Characteristic resistance to tension load (static and quasi-static loading)	see Annex B2, B3 and C4
Characteristic resistance to shear load (static and quasi-static loading)	see Annex C5
Displacements under short-term and long-term loading (static and quasi-static loading)	see Annex C6
Characteristic resistance and displacements for seismic performance categories C1 and C2	see Annex C4 to C6

Essential characteristic (fatigue loading, Assessment method A: Continuous function of fatigue resistance)	Performance
Characteristic fatigue resistance under cyclic tension loading	see Annex C1 to C3
Characteristic steel fatigue resistance $\Delta N_{Rk,s,0,n}$ ( $n = 1$ to $n = \infty$ )	
Characteristic concrete cone, splitting and pull-out fatigue resistance $\Delta N_{Rk,c,0,n}$ $\Delta N_{Rk,sp,0,n}$ $\Delta N_{Rk,p,0,n}$ ( $n = 1$ to $n = \infty$ )	

Essential characteristic (fatigue loading, Assessment method A: Continuous function of fatigue resistance)	Performance
Characteristic fatigue resistance under cyclic shear loading	
Characteristic steel fatigue resistance $\Delta V_{Rk,s,0,n}$ ( $n = 1$ to $n = \infty$ )	see Annex C1 to C3
Characteristic concrete edge fatigue resistance $\Delta V_{Rk,c,0,n}$ ( $n = 1$ to $n = \infty$ )	
Characteristic concrete pry out fatigue resistance $\Delta V_{Rk,cp,0,n}$ ( $n = 1$ to $n = \infty$ )	
Characteristic fatigue resistance under combined cyclic tension and shear loading	
Characteristic steel fatigue resistance $a_{sn}$ ( $n = 1$ to $n = \infty$ )	see Annex C1 to C3
Load transfer factor for cyclic tension, shear and combined tension and shear loading	
Load transfer factor $\psi_{FN}, \psi_{FV}$	see Annex C1 to C3

**3.2 Hygiene, health and the environment (BWR 3)**

Essential characteristic	Performance
Content, emission and/or release of dangerous substances	No performance assessed

**4 Assessment and verification of constancy of performance (AVCP) system applied, with reference to its legal base**

In accordance with European Assessment Document No. 330250-00-0601, the applicable European legal act is: [96/582/EC].

The system to be applied is: 1

**5 Technical details necessary for the implementation of the AVCP system, as provided for in the applicable European Assessment Document**

Technical details necessary for the implementation of the AVCP system are laid down in the control plan deposited with Deutsches Institut für Bautechnik.

Issued in Berlin on 5 July 2023 by Deutsches Institut für Bautechnik

Dipl.-Ing. Beatrix Wittstock  
Head of Section

*beglaubigt:*  
Stiller

## Injection System W-VIZ dynamic

Anchor rod W-VIZ-A dyn		
100 M12 100 M12 A4 100 M12 HCR	125 M16 125 M16 A4 125 M16 HCR	170 M20

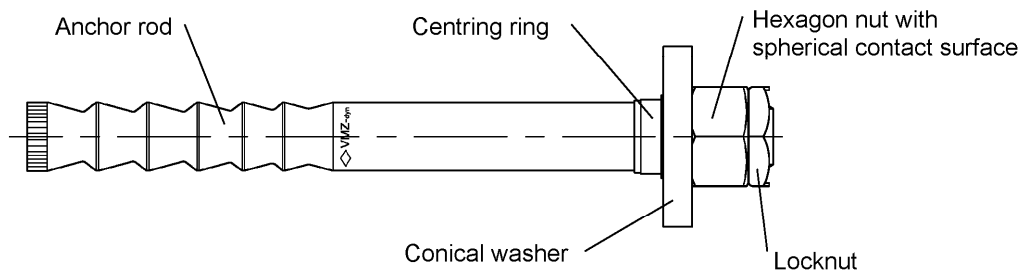

## Installation situation

### Pre-setting installation

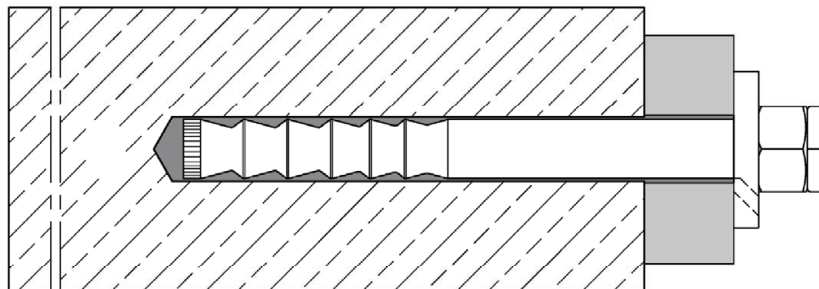

### Through-setting installation

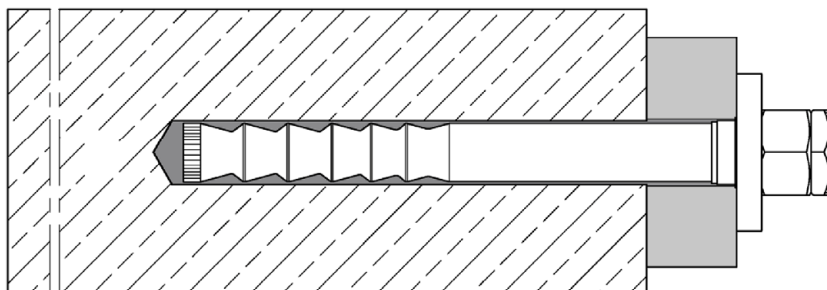

## Injection System W-VIZ dynamic

**Product description**  
Anchor rod and installation situation

**Annex A1**

## Injection System W-VIZ dynamic

Mortar cartridge



Imprint: Injection Adhesive WIT-VIZ, WIT-VM 100, WIT-VIZ express or WIT-EXPRESS, processing notes, charge number, shelf-life, hazard code, storage temperature, curing time and processing time (depending on temperature)

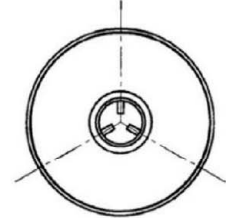

Sealing cap

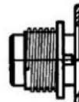

Imprint: Injection Adhesive WIT-VIZ, WIT-VM 100, WIT-VIZ express or WIT-EXPRESS, processing notes, charge number shelf-life, hazard code, storage temperature, curing time and processing time (depending on temperature)

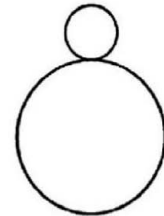

Reducing adapter



Static mixer

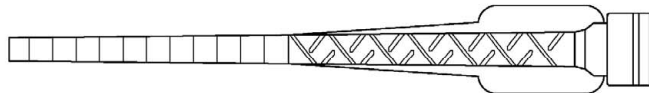

Blow-out pump



Air Blower



Cleaning Brush WIT-RMB



### Injection System W-VIZ dynamic

**Product description**  
Cartridges and cleaning tools

**Annex A2**

**Marking**

Marking: e.g.  $\diamond$  VMZ-dyn 12-25

- $\diamond$  identifying mark of manufacturing plant
- VMZ-dyn anchor identity
- 12 size of thread
- 25 maximum thickness of fixture
- A4 additional marking of stainless steel A4, if not on conical washer
- HCR additional marking of high corrosion resistant steel

Cone marking: e.g.  
J Marking of length  
d dynamic

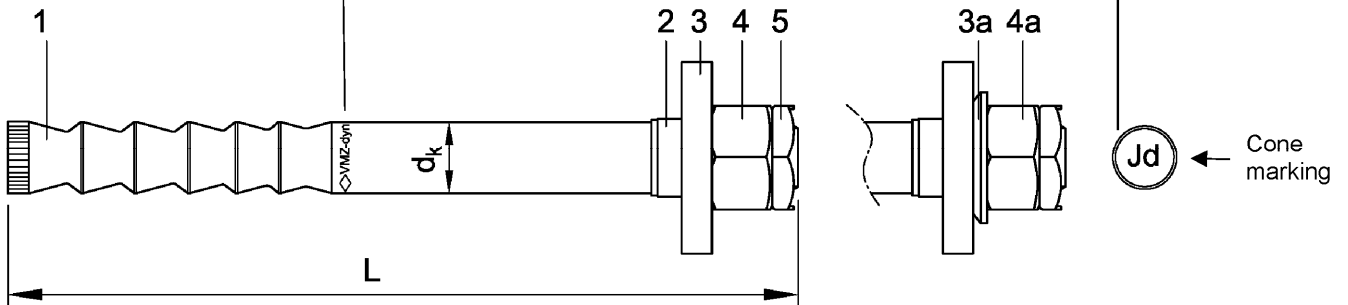

Centring ring  
(through-setting  
installation only)

Conical washer

Hexagon nut  
with spherical  
contact surface

Locknut

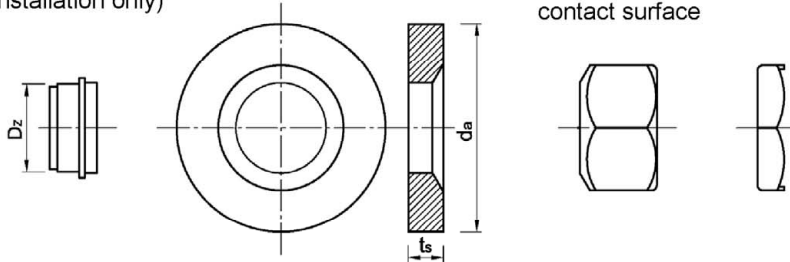

Alternatively:  
Conical washer with bore

radial angular

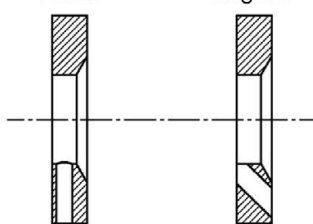

Alternatively:  
Spherical disc with hexagon nut  
(hexagon nut with spherical contact  
surface is omitted)

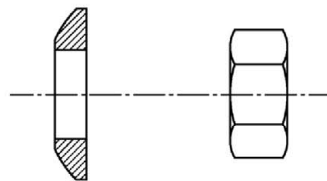

**Marking of the anchor version on the  
conical washer / conical washer with  
bore**  
(alternatively: marking on the anchor rod)

Anchor version:	Marking:
galvanized	- no marking
A4	- A4
HCR	- HCR

Marking of length	I	J	K	L	M	N	O	P	Q
Length of anchor min $\geq$	139,7	152,4	165,1	177,8	190,5	203,2	215,9	228,6	241,3
Length of anchor max $<$	152,4	165,1	177,8	190,5	203,2	215,9	228,6	241,3	254,0

Marking of length	R	S	T	U	V	W	X	Y	Z	>Z
Length of anchor min $\geq$	254,0	279,4	304,8	330,2	355,6	381,0	406,4	431,8	457,2	482,6
Length of anchor max $<$	279,4	304,8	330,2	355,6	381,0	406,4	431,8	457,2	482,6	

**Injection System W-VIZ dynamic**

**Product description**  
Components, Marking

**Annex A3**

**Table A1: Materials**

Part	Designation	Steel, zinc plated ≥ 5µm	Stainless steel A4 (CRC III)	High corrosion resistant steel HCR (CRC V)
1	Anchor rod	Steel, acc. to EN ISO 683-4:2018, galvanized and coated	High corrosion resistant steel 1.4529, acc. to EN 10088:2014, coated	
2	Centring ring	Plastic		
3	Conical washer	Steel, galvanized	Stainless steel, 1.4401 or 1.4571 acc. to EN 10088:2014	High corrosion resistant steel, 1.4529, acc. to EN 10088:2014
3a	Spherical disc	Steel, galvanized	Stainless steel, 1.4401 or 1.4571 acc. to EN 10088:2014	High corrosion resistant steel, 1.4529, acc. to EN 10088:2014
4	Hexagon nut with spherical contact surface	Steel, galvanized	EN ISO 3506-2:2020, stainless steel, Property class 70, 1.4401 or 1.4571, acc. to EN 10088:2014	EN ISO 3506-2:2020, high corrosion resistant steel, Property class 70, 1.4529 or 1.4565, acc. to EN 10088:2014
4a	Hexagon nut			
5	Locknut	Steel, galvanized	Stainless steel, 1.4401 or 1.4571 acc. to EN 10088:2014	High corrosion resistant steel, 1.4565, 1.4529 or 1.4547, acc. to EN 10088:2014
6	Mortar Cartridge	Vinylester resin, styrene-free		

**Table A2: Dimensions**

Part	Anchor size			100 M12	125 M16	170 M20
1	Anchor rod	Thread	-	M12	M16	M20
		Effective anchorage depth	$h_{ef} \geq$ [mm]	100	125	170
		Shaft diameter	$d_k =$ [mm]	12,5	16,5	22,0
		Length	$L_{min}$ [mm]	143	180	242
			$L_{max}$ [mm]	531	565	623
2	Centring ring	External diameter	$D_z$ [mm]	14	18	23,5
3	Conical washer	Thickness	$t_s$ [mm]	6	7	8
		External diameter	$d_a \geq$ [mm]	30	38	50
3a	Spherical disc	External diameter	$d_s =$ [mm]	24	30	36
4	Hexagon nut with spherical contact surface	Width across nut	SW [mm]	18 / 19	24	30
4a	Hexagon nut	Width across nut	SW [mm]	19	24	30
5	Locknut	Width across nut	SW [mm]	19	24	30

Injection System W-VIZ dynamic

Product description  
Materials and dimensions

Annex A4



Specifications of intended use			
Injection System W-VIZ dynamic	100 M12	125 M16	170 M20
Fatigue cyclic loading		✓	
Static and quasi-static action		✓	
Seismic action (Category C1 + C2)		✓	
Cracked or uncracked concrete		✓	
Strength classes acc. to EN 206:2013+A1:2016	C20/25 to C50/60		
Compacted reinforced or unreinforced normal weight concrete without fibers acc. to EN 206:2013+A1:2016		✓	
Temperature range I	-40 °C to +80 °C	maximum long-term temperature +50 °C maximum short-term temperature +80 °C	
<p><b>Use conditions (Environmental conditions):</b></p> <ul style="list-style-type: none"> <li>Structures subject to dry internal conditions: all materials</li> <li>For all other conditions: Intended use of materials according to Annex A4, Table A1 corresponding to the corrosion resistance class CRC to EN 1993-1-4:2006 + A1:2015</li> </ul> <p><b>Design:</b></p> <ul style="list-style-type: none"> <li>Anchorage are designed under the responsibility of an engineer experienced in anchorages and concrete work.</li> <li>Verifiable calculation notes and drawings are prepared taking account of the loads to be anchored. The position of the anchor is indicated on the design drawings (e.g. position of the anchor relative to reinforcement or to supports, etc.)</li> <li>Anchorage are designed according to: <ul style="list-style-type: none"> <li>- EOTA TR 061:2020 (Design method I and II) or</li> <li>- EN 1992-4:2018</li> </ul> </li> </ul> <p><b>Installation:</b></p> <ul style="list-style-type: none"> <li>Anchor shall only be used as a complete fastening unit delivered in series. Components of the anchor must not be replaced.</li> <li>Anchor installation carried out by appropriately qualified personnel and under the supervision of the site manager.</li> <li>Installation admissible in dry and wet concrete and in water-filled borehole.</li> <li>Drill hole must be cleaned directly prior to installation of the anchor or the drill hole has to be protected against re-contamination in an appropriate way until dispensing the mortar in the drill hole.</li> <li>Water filled drill holes must not be polluted – otherwise the cleaning of the drill hole must be repeated.</li> <li>The anchor component installation temperature shall be at least +5 °C; during curing of the injection mortar the temperature of the concrete must not fall below -15 °C (for the standard variation of temperature after installation).</li> <li>It must be ensured that icing does not occur in the drill hole.</li> <li>Installation direction D3: vertically downwards and upwards as well as horizontally.</li> <li>Drilling by hammer drill bit, compressed air drill or vacuum drill bit.</li> <li>The filling of the annular gap can be omitted if it is ensured that the anchor is only loaded in axial direction.</li> </ul>			
Injection System W-VIZ dynamic			Annex B1
Intended use Specifications			

**Table B1: Installation parameters**

Anchor size / version			100 M12	100 M12 A4 100 M12 HCR	125 M16	125 M16 A4 125 M16 HCR	170 M20
Effective anchorage depth	$h_{ef} \geq$	[mm]	100		125		170
Nominal diameter of drill hole	$d_0 =$	[mm]	14		18		24
Depth of drill hole <sup>1)</sup>	$h_0 \geq$	[mm]	105		130		180
Diameter of cleaning brush	$D \geq$	[mm]	15,0		19,0		25,0
Installation torque	$T_{inst} =$	[Nm]	30		50		80
Diameter of clearance hole in the fixture	$d_f =$	[mm]	15		19		25
Fixture thickness <sup>2)</sup>	$t_{fix,min} \geq$	[mm]	12		16		20
	$t_{fix,max} \leq$	[mm]	200				
Overstand	$h_p =$	[mm]	$31 + t_{fix}$	$24 + t_{fix}$	$39 + t_{fix}$	$30 + t_{fix}$	$48 + t_{fix}$

<sup>1)</sup> If the present fixture thickness is lower than the maximum fixture thickness of the anchor, the depth of drill hole should be increased accordingly

<sup>2)</sup>  $t_{fix,min}$  may be replaced by  $t_{fix,min,red}$ , if, when determining the anchor under the highest load, the action  $\Delta V_{Ed}$  is smaller than the fatigue resistance in transverse direction

$$t_{fix,min,red} = \left( 0,5 + 0,5 \cdot \frac{\Delta V_{Ed}}{\Delta V_{Rd,s,E,n} * \psi_{FV}} \right) \cdot t_{fix,min}$$

**Pre-setting installation**

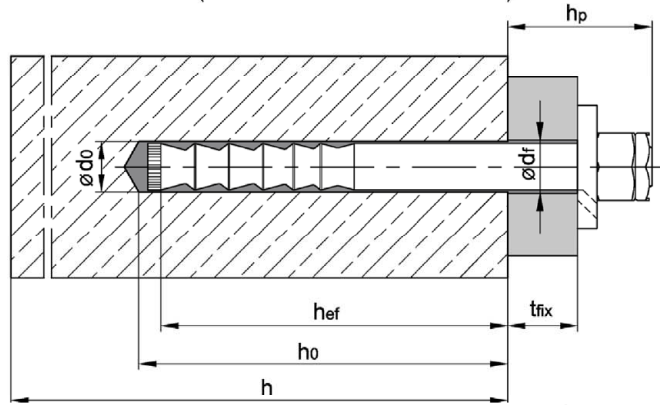

**Through-setting installation**

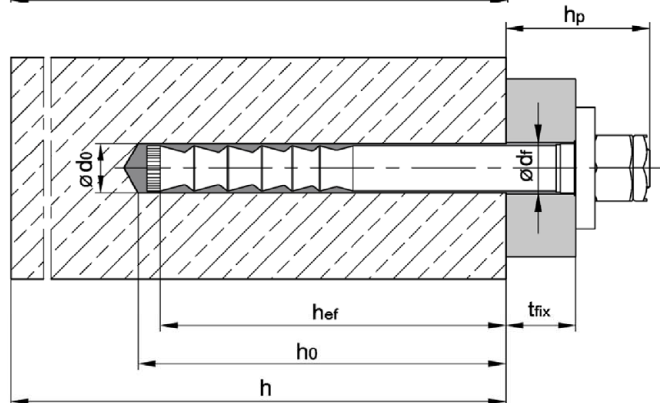

**Injection System W-VIZ dynamic**

**Intended use**  
Installation parameters

**Annex B2**

**Table B2: Minimum thickness of concrete and minimum spacing and edge distance**

Anchor size			100 M12	125 M16	170 M20
Minimum thickness of concrete member	$h_{min}$	[mm]	130	160	220
<b>Cracked concrete</b>					
Minimum spacing	$s_{min}$	[mm]	50	60	80
Minimum edge distance <sup>1)</sup>	$c_{min}$	[mm]	70 (50)	80 (60)	110 (80)
<b>Uncracked concrete</b>					
Minimum spacing	$s_{min}$	[mm]	80	60	80
Minimum edge distance	$c_{min}$	[mm]	75	80	110

<sup>1)</sup> Values in brackets are valid if edge reinforcement  $d = 8$  mm is installed

**Injection System W-VIZ dynamic**

**Intended use**  
Minimum thickness of concrete, spacing and edge distances

**Annex B3**

**Table B3: Processing time and curing time, WIT-VIZ or WIT-VM 100**

Temperature in the drill hole	Maximum processing time	Minimum curing time in dry concrete <sup>1)</sup>
- 15 °C to - 10 °C	45 min	7 d
- 9 °C to - 5 °C	45 min	10:30 h
- 4 °C to - 1 °C	45 min	6:00 h
0 °C to + 4 °C	20 min	3:00 h
+ 5 °C to + 9 °C	12 min	2:00 h
+ 10 °C to + 19 °C	6 min	1:20 h
+ 20 °C to + 29 °C	4 min	45 min
+ 30 °C to + 34 °C	2 min	25 min
+ 35 °C to + 39 °C	1,4 min	20 min
+ 40 °C	1,4 min	15 min
Cartridge temperature $\geq 5^{\circ}\text{C}$		

<sup>1)</sup> Curing time in wet concrete shall be doubled

**Table B4: Processing time and curing time, WIT-VIZ express or WIT-EXPRESS**

Temperature in the drill hole	Maximum processing time	Minimum curing time in dry concrete <sup>1)</sup>
- 5 °C to - 1 °C	20 min	4:00 h
0 °C to + 4 °C	10 min	2:00 h
+ 5 °C to + 9 °C	6 min	1:00 h
+ 10 °C to + 19 °C	3 min	40 min
+ 20 °C to + 29 °C	1 min	20 min
+ 30 °C	1 min	10 min
Cartridge temperature $\geq 5^{\circ}\text{C}$		

<sup>1)</sup> Curing time in wet concrete shall be doubled

<b>Injection System W-VIZ dynamic</b>	<b>Annex B4</b>
<b>Intended use</b> Processing time and curing time	

## Installation instructions – Through-setting installation

Hole drilling		
<b>1</b>		Drill hole perpendicular to concrete surface with hammer drill, compressed air drill or vacuum drill bit.
<b>Cleaning</b>		<b>Drill hole must be cleaned directly prior to installation of the anchor</b>
<b>all sizes</b>		<b>Cleaning with compressed air</b>
<b>2a</b>		Connect Air Blower to compressed air (min. 6 bar, oil-free). Open air valve and blow out drill hole along the entire depth with back and forth motion at least <b>two times</b> .
<b>2b</b>		Check diameter of Cleaning Brush. If brush can be pushed into the drill hole without any resistance, it must be replaced. Chuck brush into drill machine. Turn on drill machine. Brush drill hole back and forth along the entire drill hole depth at least <b>two times</b> while rotated by drill machine.
<b>2c</b>		Connect Air Blower to compressed air (min. 6 bar, oil-free). Open air valve and blow out drill hole along the entire depth with back and forth motion at least <b>two times</b> .
<b>2</b>	<b>M12 - M16</b>	<b>Manual cleaning</b> (alternative cleaning method)
<b>2a</b>		Blow out drill hole from the bottom using Blow-out Pump at least <b>two times</b> .
<b>2b</b>		Check diameter of Cleaning Brush. If brush can be pushed into the drill hole without any resistance, it must be replaced. Chuck brush into drill machine. Turn on drill machine. Brush drill hole back and forth along the entire drill hole depth at least <b>two times</b> while rotated by drill machine.
<b>2c</b>		Blow out drill hole from the bottom using Blow-out Pump at least <b>two times</b> .
<b>Injection System W-VIZ dynamic</b>		<b>Annex B5</b>
<b>Intended use</b> Installation instructions – Through-setting installation		

## Installation instructions – Through-setting installation (continuation)

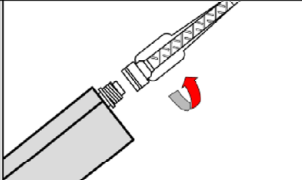
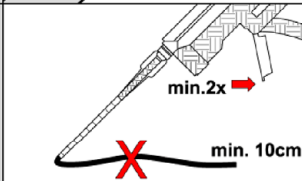
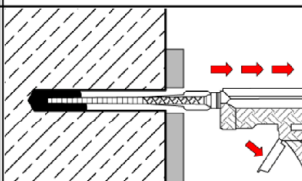
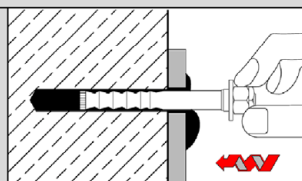
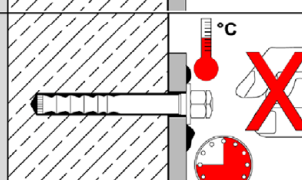
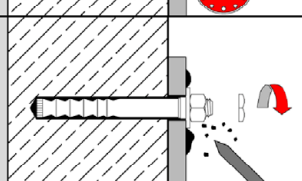
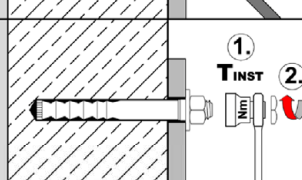
Injection		
3		Check minimum shelf-life on cartridge. Never use when expired. Remove cap from cartridge. Screw static mixer on cartridge. When using a new cartridge always use a new static mixer. Never use cartridge without static mixer and never use static mixer without helix inside.
4		Insert cartridge in dispenser. Before injecting discard mortar (at least 2 full strokes or a line of 10 cm) until it shows a consistent grey colour. Never use this mortar.
5		Prior to injection, check if static mixer reaches the bottom of the drill hole. If it does not reach the bottom, plug mixer extension onto static mixer, in order to properly fill the drill hole. Fill hole with a sufficient quantity of injection mortar. Start from the bottom of the drill hole and work out to avoid trapping air pockets.
Insertion of anchor rod		
6		Insert the pre-assembled anchor within processing time by hand, rotating slightly up to the full embedment depth, until the conical washer is in contact with the fixture. The anchor rod is properly set when the annular gap between anchor rod and fixture is completely filled. If no mortar is visible on the surface of the fixture, pull out the anchor rod immediately, let the mortar cure, drill out the hole and start again from step 2.
7		Follow minimum curing time shown in Annex B4 as well as on cartridge label. During curing time anchor rod must not be moved or loaded.
8		Remove excess mortar after curing time. Remove locknut.
9		1. Apply installation torque $T_{inst}$ according to Table B1 by using torque wrench. 2. Screw on locknut until hand tight then tighten $\frac{1}{4}$ to $\frac{1}{2}$ turn using a screw wrench.

Injection System W-VIZ dynamic

Intended use  
Installation instructions – Through-setting installation (continuation)

Annex B6

## Installation instructions – Pre-setting installation

Hole drilling		
<b>1</b>		Drill perpendicular to concrete surface with hammer drill, vacuum drill or compressed air drill.
<b>Cleaning</b>		<b>Drill hole must be cleaned directly prior to installation of the anchor</b>
<b>all sizes</b>		<b>Cleaning with compressed air</b>
<b>2a</b>		Connect Air Blower to compressed air (min. 6 bar, oil-free). Open air valve and blow out drill hole along the entire depth with back and forth motion at least <b>two times</b> .
<b>2b</b>		Check diameter of Cleaning Brush. If brush can be pushed into the drill hole without any resistance, it must be replaced. Chuck brush into drill machine. Turn on drill machine. Brush drill hole back and forth along the entire drill hole depth at least <b>two times</b> while rotated by drill machine.
<b>2c</b>		Connect Air Blower to compressed air (min. 6 bar, oil-free). Open air valve and blow out drill hole along the entire depth with back and forth motion at least <b>two times</b> .
<b>2</b>	<b>M12 - M16</b>	<b>Manual cleaning</b> (alternative cleaning method)
<b>2a</b>		Blow out drill hole from the bottom using Blow-out Pump at least <b>two times</b> .
<b>2b</b>		Check diameter of Cleaning Brush. If brush can be pushed into the drill hole without any resistance, it must be replaced. Chuck brush into drill machine. Turn on drill machine. Brush drill hole back and forth along the entire drill hole depth at least <b>two times</b> while rotated by drill machine.
<b>2c</b>		Blow out drill hole from the bottom using Blow-out Pump at least <b>two times</b> .

Injection System W-VIZ dynamic

Intended use  
Installation instructions – Pre-setting installation

Annex B7

## Installation instructions – Pre-setting installation (continuation)

Injection		
3		Check minimum shelf-life on cartridge. Never use when expired. Remove cap from cartridge. Screw static mixer on cartridge. When using a new cartridge always use a new Mixer Nozzle. Never use cartridge without static mixer and never use static mixer without helix inside.
4		Insert cartridge in Dispenser. Before injecting discard mortar (at least 2 full strokes or a line of 10 cm) until it shows a consistent grey colour. Never use this mortar.
5		Prior to injection check if static mixer reaches the bottom of the drill hole. If it does not reach the bottom, plug mixer extension onto static mixer in order to properly fill the drill hole. Fill hole with a sufficient quantity of injection mortar. Start from the bottom of the drill hole and work out to avoid trapping air pockets.
Insertion of anchor rod		
6		Mark the embedment depth on the anchor rod. Insert the anchor rod by hand, rotating slightly up within processing time. The anchor rod is properly set when excess mortar seeps from the hole. If the hole is not completely filled, pull out anchor rod, let mortar cure, drill out hole and start again from step 2.
7		Follow minimum curing time shown in Annex B4 as well as on cartridge label. During curing time anchor rod must not be moved or loaded.
8		Remove excess mortar after curing time.
9		<ol style="list-style-type: none"> <li>1. Fixture, washer and nut (without centring ring) can be mounted.</li> <li>2. Apply installation torque <math>T_{inst}</math> according to Table B1 by using torque wrench.</li> <li>3. Screw on locknut hand-tight then tighten <math>\frac{1}{4}</math> to <math>\frac{1}{2}</math> turn using a screw wrench.</li> </ol>
10		Annular gap between anchor rod and fixture must be filled with injection mortar through the bore of the conical washer using the adapter plugged onto the static mixer. The annular gap is properly filled when excess mortar seeps out.

### Injection System W-VIZ dynamic

Intended use  
Installation instructions – Pre-setting installation (continuation)

Annex B8



### Installation instructions – Installation with clearance between concrete and anchor plate (if the fastener is only loaded in axial direction)

Work steps 1 - 5 as illustrated in Annex B5 and B6

#### Insertion of anchor rod

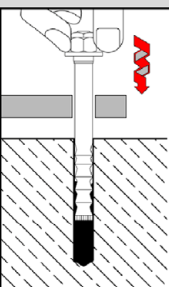
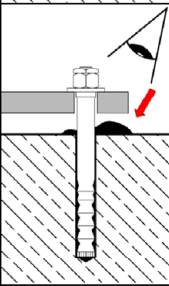
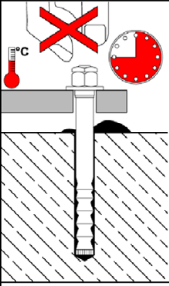
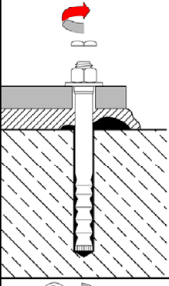
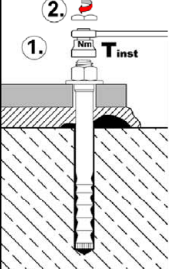
6		<p>Inserting the pre-assembled anchor within processing time by hand, rotating slightly until the conical washer lies against the fixture.</p>
7		<p>Check for excess mortar seeping out of the hole. If the hole is not completely filled, pull out anchor rod, let mortar cure, drill out hole and start again from step 2.  The annular gap in the fixture does not have to be filled.</p>
8		<p>Follow minimum curing time shown in Annex B4 as well as on cartridge label. During curing time anchor rod must not be moved or loaded.</p>
9		<p>Remove locknut after curing time and backfilling of anchor plate.</p>
10		<ol style="list-style-type: none"> <li>1. Apply installation torque <math>T_{inst}</math> according to Annex B2 (Table B1) by using torque wrench.</li> <li>2. Screw on locknut hand-tight then tighten <math>\frac{1}{4}</math> to <math>\frac{1}{2}</math> turn using a screw wrench.</li> </ol>

Injection System W-VIZ dynamic

**Intended use**  
Installation instructions – Installation with clearance between concrete and anchor plate

**Annex B9**

**Table C1: Characteristic values of the fatigue resistance under tension load after n load cycles without static actions ( $F_{Elod} = 0$ ) design method I according to TR 061**

Anchor size / version		100 M12	100 M12 A4 100 M12 HCR	125 M16	125 M16 A4 125 M16 HCR	170 M20
<b>Steel failure</b>						
Characteristic resistance without static actions	[kN]	$\Delta N_{Rk,s,0,n}$				
Number of load cycles n	1	53,9	53,9	83,4	83,4	112,1
	$\leq 10^3$	48,3	52,6	78,8	72,5	92,7
	$\leq 3 \cdot 10^3$	45,9	50,9	77,1	68,2	89,9
	$\leq 10^4$	41,4	47,6	73,1	62,4	83,4
	$\leq 3 \cdot 10^4$	35,9	42,8	66,3	56,7	73,8
	$\leq 10^5$	29,1	36,3	55,8	50,5	60,9
	$\leq 3 \cdot 10^5$	24,2	30,1	45,5	45,7	50,7
	$\leq 10^6$	21,1	24,9	37,4	41,8	44,9
	$> 10^6$	20,1	21,2	34,0	37,3	43,5
Partial factor	$\gamma_{Ms,fat,n}$	[-] according to TR 061, Eq. (3)				
Exponent for combined loading	$\alpha_{sn}$	[-]	1,5	1,2	1,5	1,5
<b>Pull-out</b>						
Characteristic resistance without static actions	$\Delta N_{Rk,p,0,n}$	[kN]	$(\Delta N_{Rk,s,0,n} / \gamma_{Ms,fat,n}) \cdot \gamma_{Mp,fat}$			
Partial factor	$\gamma_{Mp,fat}$	[-]	1,5			
<b>Concrete failure</b>						
Characteristic resistance without static actions	$\Delta N_{Rk,c,0,n}$	[kN]	$\eta_{k,c,N,fat,n} \cdot N_{Rk,c}^{1)}$			
	$\Delta N_{Rk,sp,0,n}$	[kN]	$\eta_{k,c,N,fat,n} \cdot N_{Rk,sp}^{1)}$			
Reduction factor		[-]	$\eta_{k,c,N,fat,n}$			
Number of load cycles n	1		1,0			
	$\leq 10^3$		0,932			
	$\leq 3 \cdot 10^3$		0,893			
	$\leq 10^4$		0,841			
	$\leq 3 \cdot 10^4$		0,794			
	$\leq 10^5$		0,750			
	$\leq 3 \cdot 10^5$		0,722			
	$\leq 10^6$		0,704			
	$> 10^6$		0,693			
Effective anchorage depth	$h_{ef}$	[mm]	100		125	170
Partial factor	$\gamma_{Mc,fat}$	[-]	1,5			
Exponent for combined loading	$\alpha_c$	[-]	1,5			
Load-transfer factor for fastener groups	$\psi_{FN}$	[-]	0,79			

<sup>1)</sup> see Table C4

**Injection System W-VIZ dynamic**

**Performance**

Characteristic fatigue resistance under tension load, design method I according to TR 061

**Annex C1**

**Table C2: Characteristic values of the fatigue resistance under shear load after n load cycles without static actions ( $F_{Elod} = 0$ ) design method I according to TR 061**

Anchor size / version		100 M12	100 M12 A4 100 M12 HCR	125 M16	125 M16 A4 125 M16 HCR	170 M20
<b>Steel failure</b>						
Characteristic resistance without static actions	[kN]	$\Delta V_{Rk,s,0,n}$				
Number of load cycles n	1	34,0		63,0	149,0	
	$\leq 10^3$	27,6	31,3	54,0	113,5	
	$\leq 3 \cdot 10^3$	23,8	28,3	47,2	91,6	
	$\leq 10^4$	18,6	23,5	36,5	65,0	
	$\leq 3 \cdot 10^4$	14,1	18,1	26,2	43,9	
	$\leq 10^5$	10,5	12,8	18,4	29,0	
	$\leq 3 \cdot 10^5$	8,9	9,8	15,6	23,2	
	$\leq 10^6$	8,2	8,5	15,0	21,3	
	$> 10^6$	8,2		15,0	21,1	
Partial factor	$\gamma_{Ms, fat, n}$	[-] according TR 061, Eq. (3)				
Exponent for combined loading	$\alpha_{sn}$	[-]	1,5	1,2	1,5	1,5
<b>Concrete failure</b>						
Characteristic resistance without static actions	$\Delta V_{Rk, cp, 0, n}$	[kN]	$\eta_{k, c, V, fat, n} \cdot V_{Rk, cp}^{1)}$			
	$\Delta V_{Rk, c, 0, n}$	[kN]	$\eta_{k, c, V, fat, n} \cdot V_{Rk, c}^{1)}$			
Reduction factor		[-]	$\eta_{k, c, N, fat, n}$			
Number of load cycles n	1	1,0				
	$\leq 10^3$	0,799				
	$\leq 3 \cdot 10^3$	0,760				
	$\leq 10^4$	0,725				
	$\leq 3 \cdot 10^4$	0,700				
	$\leq 10^5$	0,680				
	$\leq 3 \cdot 10^5$	0,668				
	$\leq 10^6$	0,660				
$> 10^6$	0,652					
Effective anchor length	$l_f$	[mm]	100	125	170	
Outside diameter	$d_{nom}$	[mm]	14	18	24	
Partial factor	$\gamma_{Mc, fat}$	[-]	1,5			
Exponent for combined loading	$\alpha_c$	[-]	1,5			
Load-transfer factor for fastener groups	$\psi_{FV}$	[-]	0,81			

<sup>1)</sup> see Table C4

**Injection System W-VIZ dynamic**

**Performance**

Characteristic fatigue resistance under shear load for design method I according to TR 061

**Annex C2**

**Table C3: Characteristic fatigue limit resistance for design according to EN 1992-4:2018 and design method II according to TR 061**

Anchor size / version			100 M12	100 M12 A4 100 M12 HCR	125 M16	125 M16 A4 125 M16 HCR	170 M20
<b>Tension load</b>							
<b>Steel failure</b>							
Characteristic fatigue resistance	$\Delta N_{Rk,s,0,\infty}$	[kN]	20,1	21,2	34,0	37,3	43,5
Partial factor	$\gamma_{Ms,fat}$	[-]	1,35				
Load-transfer factor for fastener groups	$\psi_{FN}$	[-]	0,79				
<b>Pull-out</b>							
Characteristic fatigue resistance	$\Delta N_{Rk,p,0,\infty}$	[kN]	$(\Delta N_{Rk,s,0,\infty} / \gamma_{Ms,N,fat}) \cdot \gamma_{Mp,fat}$				
Partial factor	$\gamma_{Mp,fat}$	[-]	1,5				
<b>Concrete failure</b>							
Characteristic fatigue resistance	$\Delta N_{Rk,c,0,\infty}$	[kN]	$0,693 N_{Rk,c}^{1)}$				
	$\Delta N_{Rk,sp,0,\infty}$	[kN]	$0,693 N_{Rk,sp}^{1)}$				
Effective anchorage depth	$h_{ef}$	[mm]	100		125		170
Partial factor	$\gamma_{Mc,fat}$	[-]	1,5				
<b>Shear load</b>							
<b>Steel failure without lever arm</b>							
Characteristic fatigue resistance	$\Delta V_{Rk,s,0,\infty}$	[kN]	8,2		15,0		21,1
Partial factor	$\gamma_{Ms,fat}$	[-]	1,35				
Load-transfer factor for fastener groups	$\psi_{FV}$	[-]	0,81				
<b>Concrete pry-out failure</b>							
Characteristic fatigue resistance	$\Delta V_{Rk,cp,0,\infty}$	[kN]	$0,652 V_{Rk,cp}^{1)}$				
Partial factor	$\gamma_{Mc,fat}$	[-]	1,5				
<b>Concrete edge failure</b>							
Characteristic fatigue resistance	$\Delta V_{Rk,c,0,\infty}$	[kN]	$0,652 V_{Rk,c}^{1)}$				
Effective length of anchor	$l_f$	[mm]	100		125		170
Outside diameter of anchor	$d_{nom}$	[mm]	14		18		24
Partial factor	$\gamma_{Mc,fat}$	[-]	1,5				
Exponents for combined loading	$\alpha_s$	[-]	1,5	1,2	1,5		1,5
	$\alpha_{sn}$	[-]					
	$\alpha_c$	[-]	1,5				

<sup>1)</sup> see Table C4

**Injection System W-VIZ dynamic**

**Performance**  
Characteristic **fatigue limit resistance** for design according to **EN 1992-4** and **design method II** according to **TR 061**

**Annex C3**

**Table C4: Characteristic values under tension load for static and quasi-static or seismic action**

Anchor size / version			100 M12 100 M12 A4 100 M12 HCR	125 M16 125 M16 A4 125 M16 HCR	170 M20	
<b>Steel failure</b>						
Characteristic resistance	$N_{Rk,s}$ $N_{Rk,s,C1}$ $N_{Rk,s,C2}$	[kN]	57	111	188	
Partial factor	$\gamma_{Ms}$	[-]	1,5			
<b>Pull-out failure</b>						
Characteristic resistance (C20/25)	uncracked concrete	$N_{Rk,p}$	[kN]	49,2	68,8	109
	cracked concrete	$N_{Rk,p}$	[kN]	34,4	48,1	76,3
	seismic C1	$N_{Rk,p,C1}$	[kN]	36,0	43,7	88,2
	seismic C2	$N_{Rk,p,C2}$	[kN]	17,6	26,1	59,7
<b>Concrete cone failure</b>						
Characteristic edge distance	$c_{cr,N}$	[mm]	$1,5 \cdot h_{ef}$			
Factor k1	uncracked concrete	$k_{ucr,N}$	[-]	11,0		
	cracked concrete	$k_{cr,N}$	[-]	7,7		
Effective anchorage depth	$h_{ef}$	[mm]	100	125	170	
<b>Splitting</b>						
For each proof of splitting failure, $N_{Rk,sp}$ shall be calculated according to EN 1992-4:2018, equation (7.23). The higher value for $N_{Rk,sp}$ of case 1 and case 2 may be applied for the design.						
<b>Standard thickness of concrete</b>		$h_{min,1} \geq$	[mm]	200	250	340
<b>Case 1</b>	Characteristic resistance (C20/25)	$N^0_{Rk,sp}$	[kN]	40	50	109
	Characteristic edge distance	$c_{cr,sp}$	[mm]	$1,5 \cdot h_{ef}$		
<b>Case 2</b>	Characteristic resistance	$N^0_{Rk,sp}$	[kN]	$\min [N_{Rk,p}; N^0_{Rk,c}]$		
	Characteristic edge distance	$c_{cr,sp}$	[mm]	$2 \cdot h_{ef}$	$2 \cdot h_{ef}$	$1,5 \cdot h_{ef}$
<b>Minimum thickness of concrete</b>		$h_{min,2} \geq$	[mm]	130	160	220
<b>Case 1</b>	Characteristic resistance (C20/25)	$N^0_{Rk,sp}$	[kN]	30	40	75
	Characteristic edge distance	$c_{cr,sp}$	[mm]	$1,5 \cdot h_{ef}$		
<b>Case 2</b>	Characteristic resistance	$N^0_{Rk,sp}$	[kN]	$\min [N_{Rk,p}; N^0_{Rk,c}]$		
	Characteristic edge distance	$c_{cr,sp}$	[mm]	$3 \cdot h_{ef}$	$3 \cdot h_{ef}$	$2,6 \cdot h_{ef}$
Increasing factor for $N_{Rk,p}$ and $N^0_{Rk,sp}$ (case 1)		$\psi_c$	[-]	$\left(\frac{f_{ck}}{20}\right)^{0,5}$		
Installation factor		$\gamma_{inst}$	[-]	1,0		
<b>Injection System W-VIZ dynamic</b>					<b>Annex C4</b>	
<b>Performance</b> Characteristic values for <b>tension load</b> under <b>static and quasi static</b> or <b>seismic action</b>						

**Table C5: Characteristic values under shear load for static and quasi-static or seismic action**

Anchor size / version			100 M12 100 M12 A4 100 M12 HCR	125 M16 125 M16 A4 125 M16 HCR	170 M20
<b>Steel failure without lever arm</b>					
Characteristic resistance	$V^{0}_{Rk,s}$	[kN]	34	63	149
	$V^{0}_{Rk,s,C1}$	[kN]	27,2	39,1	82,3
	$V^{0}_{Rk,s,C2}$	[kN]	27,2	50,4	108,8
Partial factor	$\gamma_{Ms}$	[-]	1,25		
Ductility factor	$k_7$	[-]	1,0		
<b>Steel failure with lever arm</b>					
Characteristic bending resistance	$M^{0}_{Rk,s}$	[Nm]	105	266	519
Partial factor	$\gamma_{Ms}$	[-]	1,25		
<b>Concrete pry-out failure</b>					
Pry-out factor	$k_8$	[-]	2,0		
<b>Concrete edge failure</b>					
Effective length of anchor in shear load	$l_f$	[mm]	100	125	170
Outside diameter of anchor	$d_{nom}$	[mm]	14	18	24
Installation factor	$\gamma_{inst}$	[-]	1,0		
Factor for anchorages with filled annular gap	$\alpha_{gap}$	[-]	1,0		

Injection System W-VIZ dynamic

**Performance**  
Characteristic values under **shear load** for **static and quasi-static** or **seismic action**

**Annex C5**

**Table C6: Displacements under tension load for static and quasi-static or seismic action**

Anchor size / version			100 M12 100 M12 A4 100 M12 HCR	125 M16 125 M16 A4 125 M16 HCR	170 M20
Tension load in <b>cracked</b> concrete	N	[kN]	17,1	24	38
Displacements	$\delta_{N0}$	[mm]	0,6	0,7	0,8
	$\delta_{N\infty}$	[mm]	1,3	1,3	1,3
Tension load in <b>uncracked</b> concrete	N	[kN]	24	33	53,3
Displacements	$\delta_{N0}$	[mm]	0,4	0,6	0,6
	$\delta_{N\infty}$	[mm]	1,3	1,3	1,3
Displacements under <b>seismic tension loads C2</b>					
Displacements	$\delta_{N,C2(DLS)}$	[mm]	1,1	1,5	1,9
	$\delta_{N,C2(ULS)}$	[mm]	3,0	4,4	4,5

**Table C7: Displacements under shear load for static and quasi-static or seismic action**

Anchor size / version			100 M12 100 M12 A4 100 M12 HCR	125 M16 125 M16 A4 125 M16 HCR	170 M20
Shear load	V	[kN]	19,3	36	75
Displacements	$\delta_{V0}$	[mm]	3,3	3,8	4,3
	$\delta_{V\infty}$	[mm]	5,0	5,7	6,5
Displacements under <b>seismic shear loads C2</b>					
Displacements	$\delta_{V,C2(DLS)}$	[mm]	2,5	2,9	3,5
	$\delta_{V,C2(ULS)}$	[mm]	5,1	6,8	9,3

Injection System W-VIZ dynamic

**Performance**  
Displacements under **static and quasi-static** or **seismic action**

**Annex C6**